

i-Kids

Kids' Magical Wonderlands for E-Learning

Simple

to use by communicating ideas through storytelling.

Supporting

parent-child interactions by focusing on gaining more knowledge.

Sufficient

information via smart classification.



*An Easy Way to
Make Your Kids Smarter*

No installation × No subscription × No monthly charge

Actually nothing annoying is required. Every parent should have an i-Kids for your kids.

8 Topics For E-Learning

- English Learning
- Homework Helper
- Picture Stories
- Kid's Literature
- Kid's Encyclopedia
- Game Center
- Fun Stuff
- Multimedia Center

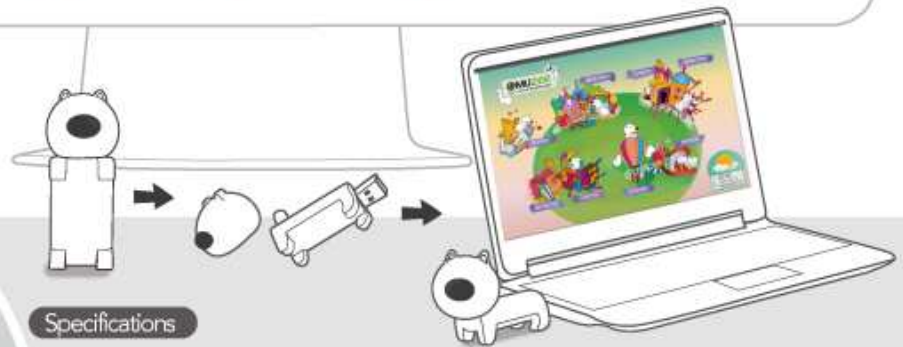
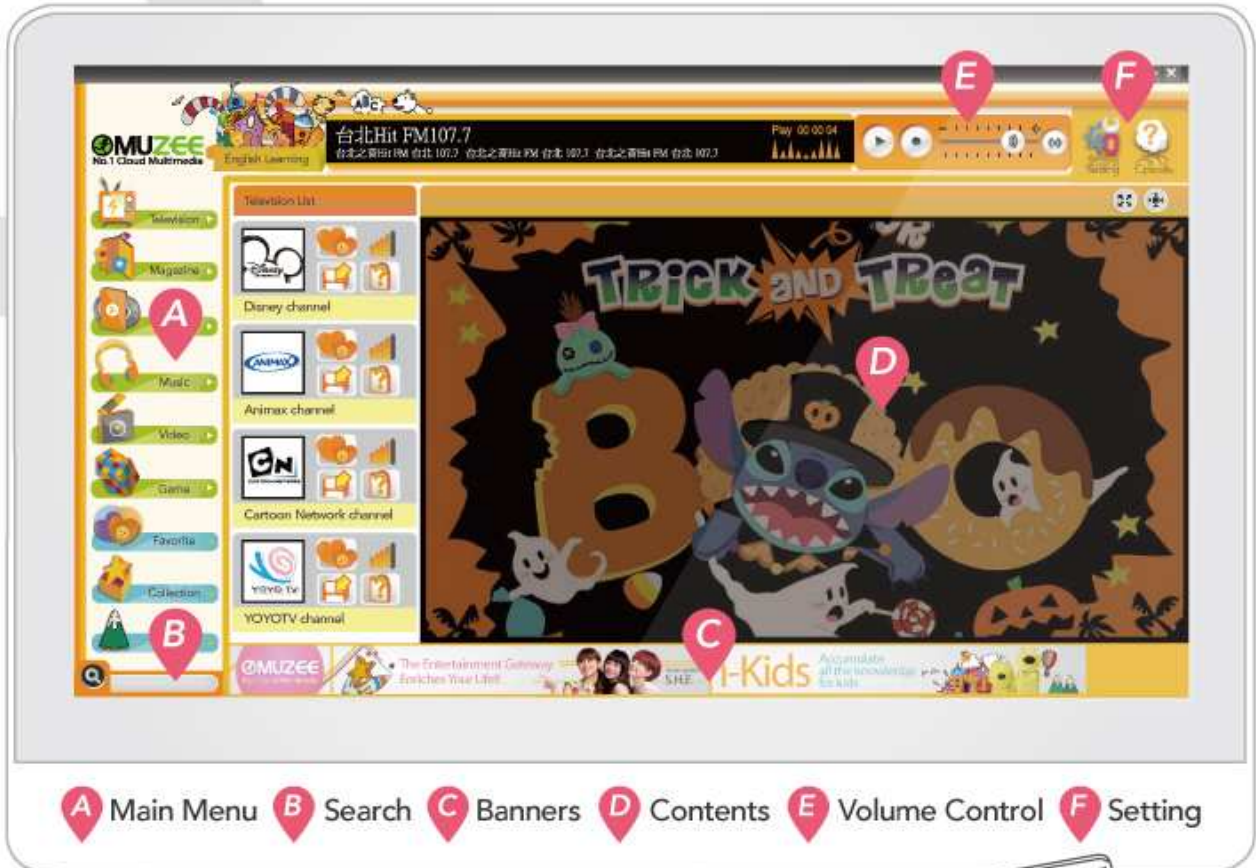

Specifications

CPU 1 GHz or above	Browser IE6 or above	Adobe Flash Player Version 10 or above
Memory 512MB or above	USB USB 2.0 or above	Windows Media Player Version 9 or above
Free Hard disk Space 10MB above		
Display standard screen/ 1280 x 1024 wide-screen/ 1280 x 800	Operating Systems Windows XP SP2 or above/ Windows Vista/ Windows 7	
Networking Radio/ approx. 99% Internet Radio stations played upon 1Mbps bandwidth. TV/ approx. 80% Internet TV stations played upon 2 Mbps bandwidth.		

⚠ The smoothness of playing broadcasted content back and successful connections are subject to internal and external bandwidth provided by your ISP (Internet Service Provider).

Registered / Enregistré 03/06/2011

No 001872888-0001



**OHIM – OFFICE FOR HARMONIZATION
IN THE INTERNAL MARKET
TRADE MARKS AND DESIGNS**

CERTIFICATE OF REGISTRATION

This Certificate of Registration is hereby issued for the Registered Community Design identified below. The corresponding entries have been recorded in the Register of Community Designs.

**OHMI – OFFICE DE L'HARMONISATION
DANS LE MARCHÉ INTÉRIEUR
MARQUES, DESSINS ET MODÈLES**

**CERTIFICAT
D'ENREGISTREMENT**

Le présent Certificat d'Enregistrement est émis pour le Dessin ou Modèle Communautaire enregistré spécifié ci-dessous. Les inscriptions afférentes ont été portées au Registre des Dessins ou Modèles Communautaires.

The President / Le Président

António Campinos



- 21 001872888-0001
25 EN - FR
22 03/06/2011
15 03/06/2011
45 08/06/2011
11 001872888-0001
72 Po-Ching SUNG
73 MTECH CORPORATION
16 F., No. 30, Beiping E. Rd., Jhongjheng Dist.,
Taipei City 100
TAIWÁN
74 BREVALEX
95, rue d'Amsterdam
F-75378 Paris Cedex 8
FRANCIA
51 14 - 02
54 **BG** - Флаш драйвъри
ES - Unidades de flash
CS - Flash diský
DA - Flashdrev
DE - Flash-Laufwerke
ET - Válmáldraivid
EL - Οδηγοί μνήμης φλας
EN - Flash drives
FR - Unités Flash
IT - Unità flash
LV - "flash" diskdzīņi
LT - Flash atminties kaupikliai
HU - Flash-meghajtók
MT - Flexx drajvs
NL - Flashdrives
PL - Pamięci typu flash
RO - Unități de stocare tip flash
PT - Unidades de memória flash
SK - Flash jednotky
SL - Flash gonilniki
FI - Flash-muistit
SV - Flashenheter

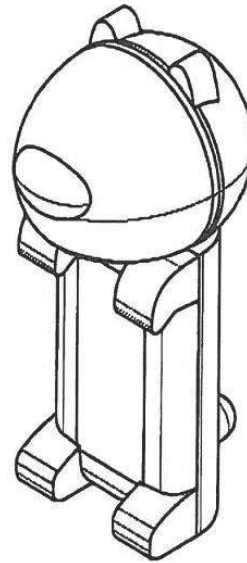

0001.1

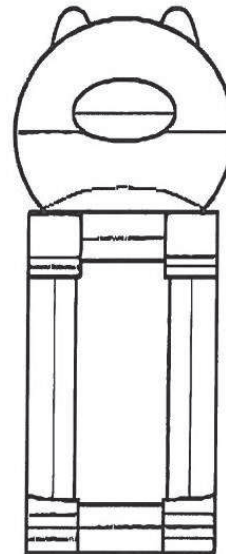

0001.2

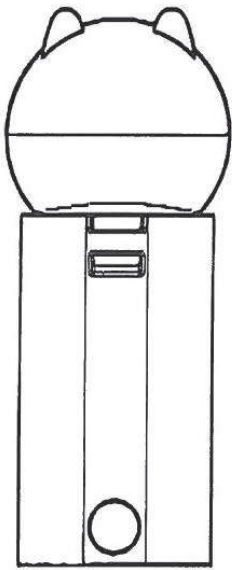

0001.3

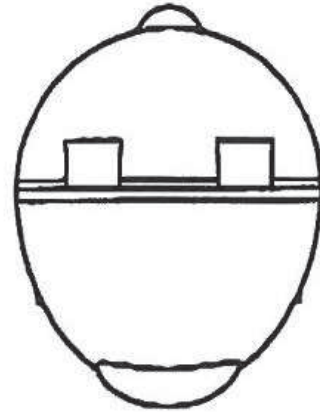

0001.5

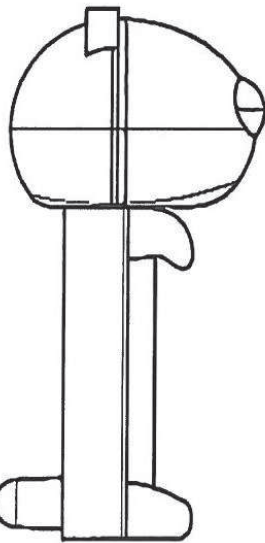

0001.4

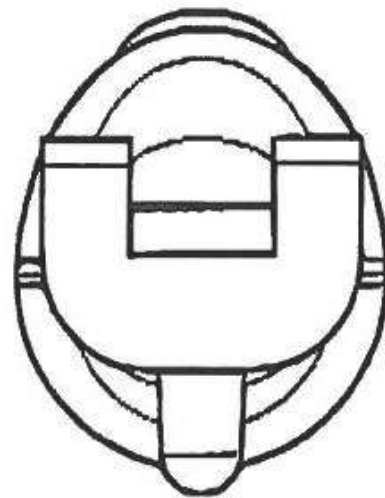

0001.6

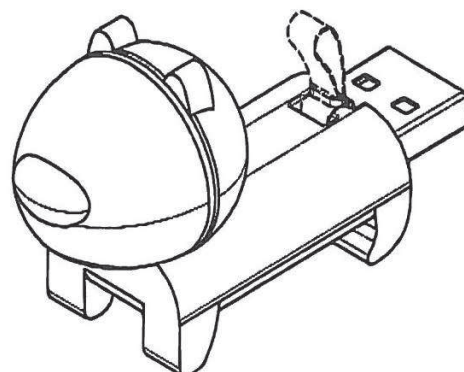

0001.7



OHIM – OFFICE FOR HARMONIZATION IN THE INTERNAL MARKET
TRADE MARKS AND DESIGNS

OHMI – OFFICE DE L'HARMONISATION DANS LE MARCHÉ INTÉRIEUR
MARQUES, DESSINS ET MODÈLES